

The selling prices are excl. VAT and other taxes/charges and ex Works.
Pricing and product availability are subject to change without notice.

Alle Preise verstehen sich netto zzgl. der gesetzlichen MwSt und ab Werk.
Änderungen von Preise, Konstruktionen und Ausstattungen vorbehalten.

© 2023





PRICELIST 2023



FX SERIES

Hydraulic Hammers
Hydraulikhämmer

Model	T. 	KG 	€ Euro
FX-10	0.8 - 1.6	100	6.000
FX-20	1.5 - 3.0	135	6.200
FX-30	2 - 4	160	6.900
FX-40	3 - 5	195	7.800
FX-50	4 - 7	320	9.200
FX-70	6 - 9	410	11.100
FX-90	7 - 12	550	13.900
FX-120	10 - 16	920	18.300
FX-160	14 - 18	1.320	26.000
FX-200	16 - 24	1.580	29.900
FX-220	19 - 26	1.900	33.100
FX-340	28 - 40	2.500	44.300
FX-500	42 - 55	4.150	68.000



Soundproofed	Schallschutz
Vibration Damper	Vibrations Dämpfer
Bigger Nitrogen chamber	Größeres Gas Raum
Frequency valve	Frequenz Ventil
Bigger control valve	Größeres Ventil
Auto Lube	Auto-Lube Schmiersystem
Accumulator	Akkumulator
Heavy Duty Housing	Heavy Duty Gehäuse
Retainer pin	Sperrachse
Piston	Schlagkolben
Chisel	Meißel



Hydraram FX-Series Pro

- AutoLubrication
- AutoStop
- DustControl
- PowerSelect
- VibrosilencedPro
- EnergyRecovery



Hydraram FX-Series Pro

- AutoSchmierung
- AutoStop
- StaubStop
- PowerSelect
- VibrosilencedPro
- EnergieRückgewinnung

FX PRO SERIES

Hydraulic Hammers



Hydraulikhämmer

Model	 T.	 KG	€ Euro
FX-6 Pro	0.5 - 1.2	60	5.600
FX-25 Pro	1.0 - 2.4	122	6.500
FX-35 Pro	2.0 - 3.8	195	8.000
FX-45 Pro	2.6 - 4.5	260	10.600
FX-55 Pro	3.6 - 6.5	345	11.500
FX-65 Pro	5.0 - 8.5	470	13.300
FX-75 Pro	6.5 - 10.0	570	15.000
FX-95 Pro X	9.0 - 15	840	20.700
FX-110 Pro X	12 - 18	930	24.200
FX-130 Pro X	14 - 21	1.190	30.200
FX-170 Pro X	16 - 24	1.420	34.000
FX-190 Pro X	18 - 26	1.560	36.800
FX-210 Pro X	20 - 28	1.820	40.900
FX-260 Pro X	24 - 32	2.050	49.800
FX-320 Pro X	25 - 36	2.380	60.400
FX-380 Pro X	30 - 42	2.800	65.300
FX-460 Pro X	34 - 50	3.200	76.600
FX-520 Pro X	42 - 60	3.800	86.700
FX-680 Pro X	47 - 78	4.600	109.800
FX-740 Pro X	60 - 90	5.800	161.100
FX-820 Pro X	65 - 100	7.100	214.100
FX-1200 Pro X	88 - 150	10.400	288.500





MK SERIES



Multiprocessors
Multiprozessoren



Model	T. 	 KG	€ Euro
MK-7	6 - 14	410	27.800
MK-10	9 - 18	600	30.000
MK-13	15 - 20	795	38.200
MK-18	18 - 25	1.180	51.900
MK-23	25 - 35	1.465	59.600
MK-28	35 - 45	1.970	65.600
MK-38	45 - 60	2.150	75.200
MK-55	55 - 78	3.420	126.700
MK-75	75 - 100	5.020	191.900



Data refers to the body without jaw kit.
Daten bezogen auf das Gehäuse ohne Gebiß.

Pulverizer Jaw Pulverisierer Gebiß	Model	 KG	€ Euro
	MK-7	250	12.800
MK-10	410	17.600	
 P	MK-13	635	23.500
	MK-18	680	24.400
	MK-23	1.035	32.500
	MK-28	1.270	38.300
	MK-38	1.720	46.500
	MK-55	2.940	76.600
	MK-75	3.940	99.700

Steel Jaw Stahl Gebiß	Model	 KG	€ Euro
	MK-7	210	20.200
MK-10	360	25.100	
 S	MK-13	580	31.700
	MK-18	630	36.400
	MK-23	950	43.600
	MK-28	1.240	52.900
	MK-38	1.425	59.500
	MK-55	2.280	92.500
	MK-75	2.850	125.000

Universal Jaw Universal Gebiß	Model	 KG	€ Euro
	MK-7	440	16.800
MK-10	520	26.300	
 U	MK-13	610	35.900
	MK-18	740	39.000
	MK-23	1.000	44.500
	MK-28	1.300	56.100
	MK-38	1.590	62.300
	MK-55	2.650	87.200
	MK-75	3.390	*

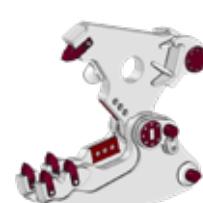
Demolition Jaw Abbruch Gebiß	Model	 KG	€ Euro
	MK-7	360	15.500
MK-10	435	22.500	
 D	MK-13	575	27.700
	MK-18	680	29.000
	MK-23	1.075	38.100
	MK-28	1.235	43.700
	MK-38	1.700	52.600
	MK-55	2.750	81.700
	MK-75	3.120	*

* Available on request
* Verfügbar auf Anfrage

Combi Jaw Kombi Gebiß	Model	KG	€ Euro
 <p>C</p>	MK-7	350	18.600
	MK-10	450	24.900
	MK-13	585	30.000
	MK-18	720	35.900
	MK-23	1.090	43.100
	MK-28	1.305	52.000
	MK-38	1.780	58.700
	MK-55	2.900	91.200
	MK-75	3.890	125.000

Tankshear Jaw Tank Gebiß	Model	KG	€ Euro
 <p>T</p>	MK-10	320	23.100
	MK-13	420	27.300
	MK-18	560	30.900
	MK-23	1.000	41.800
	MK-28	1.400	51.800
	MK-38	1.750	56.900
	MK-55	1.900	89.700
	MK-75	2.360	*

* Available on request
* Verfügbar auf Anfrage



HCC SERIES



Concrete Crushers
Betonzangen

Model	T.	KG	€ Euro
HCC-1V	1.5 - 2.5	180	17.000
HCC-2V	2 - 4	250	21.000
HCC-3V	4 - 7	300	23.900
HCC-6V	5 - 10	610	32.600
HCC-12V	10 - 17	1.230	45.800
HCC-16V	16 - 21	1.620	56.200
HCC-19V	20 - 25	1.960	69.900
HCC-24V	22 - 30	2.380	77.800
HCC-32V	29 - 38	2.960	93.500
HCC-36V	33 - 44	3.420	115.600
HCC-42V	36 - 52	3.920	123.400
HCC-58V	50 - 68	5.440	154.500
HCC-72V	66 - 88	7.140	190.100
HCC-95V	85 - 105	9.380	262.900
HCC-110V	90 - 130	11.940	329.200
HCC-130V	94 - 150	13.850	369.400
HCC-150V	100 - 200	15.800	427.000
HCC-320V	200 - 300	32.000	853.600



HCS SERIES



Combi cutters
Kombischeren

Model	 T.	 KG	€ Euro
HCS-15U	15 - 22	1.480	65.800
HCS-19U	18 - 25	1.980	70.900
HCS-32U	24 - 37	2.960	98.100
HCS-42U	32 - 50	3.820	124.200
HCS-52U	42 - 62	4.820	165.600
HCS-72U	52 - 86	7.180	231.800
HCS-120U	86 - 150	12.100	365.400
		13.300	



HCS SERIES



Combi cutters
Kombischeren

Model	 T.	 KG	€ Euro
HCS-19UP	18 - 25	2.130	77.600
HCS-32UP	24 - 37	3.140	104.600
HCS-42UP	32 - 50	4.180	133.900
HCS-52UP	42 - 62	5.600	175.300
HCS-72UP	52 - 86	7.780	248.100
HCS-120UP	86 - 150	12.850	366.900



HSS SERIES



Scrap shears
Schrottscheren

Model	 T.	 KG	€ Euro
HSS-2RV	1.5 - 3.0	185	20.700
HSS-3RV	4.0 - 5.0	300	31.800
HSS-6RV	5.0 - 8.0	610	37.400
HSS-10RV	8.0 - 12	1.020	49.700
HSS-14RV	12 - 18	1.360	62.800
HSS-22RV	18 - 23	2.180	82.900
HSS-28RV	23 - 32	2.840	91.700
HSS-34RV	30 - 42	3.360	108.700
HSS-45RV	40 - 55	4.380	130.600
HSS-52RV	52 - 65	5.160	173.200
HSS-62RV	55 - 78	6.480	193.300
HSS-82RV	75 - 100	8.230	264.400
HSS-110RV	100 - 150	11.680	339.000
HSS-140RV	140 - 170	14.300	412.000
HSS-180RV	140 - 210	18.340	593.300
HSS-220RV	200 - 280	21.850	711.900



HTS SERIES



Tankshears
Tankscheren

Model	 T.	 KG	€ Euro
HTS-22T	20 - 28	2200	*
HTS-28T	24 - 35	2850	*
HTS-38T	32 - 47	3700	*
HTS-68T	65 - 85	6500	*



HRC SERIES



Rail croppers
Schienenknacker

Model	 T.	 KG	€ Euro
HRC-20R	15 - 22	2.100	70.200
HRC-26R	22 - 34	2.680	94.100
HRC-42R	34 - 52	4.050	126.400



HFP SERIES



Fixed pulverizers
Pulverisierer Star

Model	 T.	 KG	€ Euro
HFP-4V	4 - 7	460	15.400
HFP-7V	6 - 10	740	22.200
HFP-15V	13 - 19	1.420	39.000
HFP-22V	18 - 28	2.180	51.900
HFP-28V	25 - 35	2.820	63.300
HFP-35V	33 - 45	3.420	73.800
HFP-48V	42 - 68	4.760	109.200
HFP-72V	65 - 85	6.980	143.700



HFP-M SERIES



Fixed pulverizers with magnet
Starre Pulverisierer mit Magnet

Model	 T.	 KG	€ Euro
HFP-22VM	22 - 32	2.680	74.000
HFP-28VM	28 - 38	3.480	90.200
HFP-35VM	35 - 52	4.280	100.700



HFP-RV SERIES



Fixed pulverizers with rotation
Drehbare Pulverisierer

Model	 T.	 KG	€ Euro
HFP-15RV	16 - 22	1.640	54.000
HFP-22RV	23 - 28	2.425	72.100
HFP-28RV	25 - 38	3.340	84.000
HFP-35RV	36 - 50	3.750	101.400



HRP SERIES

Rotating pulverizers
Drehbare Pulverizierer

Model	 T.	 KG	€ Euro
HRP-6V	6 - 9	570	29.600
HRP-12V	9 - 14	1.120	38.700
HRP-16V	13 - 18	1.430	51.800
HRP-20V	18 - 26	2.080	62.800
HRP-26V	23 - 30	2.630	70.100
HRP-32V	29 - 38	3.280	85.200
HRP-42V	36 - 52	4.060	103.400
HRP-62V	51 - 72	5.880	131.900
HRP-82V	68 - 88	7.860	175.200
HRP-120V	86 - 130	12.800	303.900
HRP-220V	120 - 200	22.900	634.500
HRP-280V	150 - 250	26.400	748.800

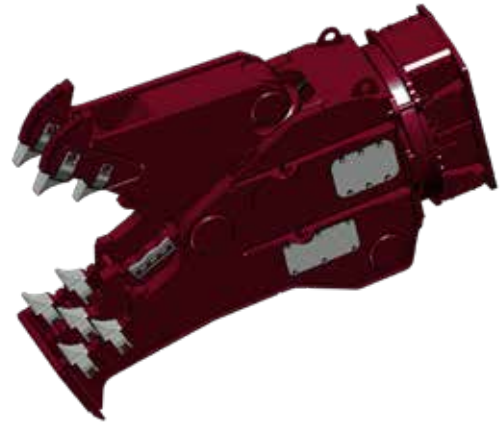

HDG SERIES

Demolition & sorting grabs

Abbruchgreifer

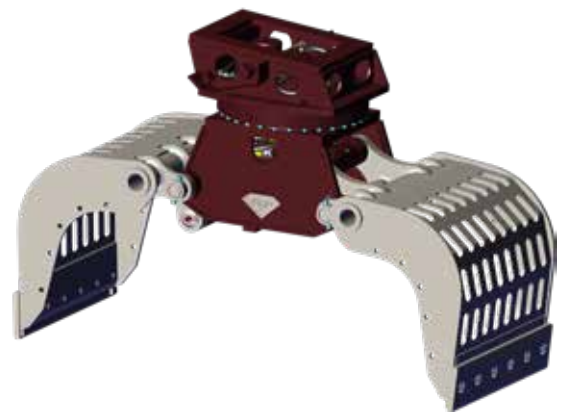

Model	T.	KG	€ Euro
HDG-8R	0.7 - 1.2	100	8.400
HDG-10R	0.7 - 2.0	120	9.100
HDG-15R	1.2 - 3.0	200	10.400
HDG-25R	3.0 - 5.0	290	12.500
HDG-34R	3.5 - 5.5	340	13.800
HDG-42R	4.0 - 6.0	400	15.100
HDG-46R	5.0 - 9.0	450	16.700
HDG-52R	7.0 - 12	560	17.700
HDG-62R	10 - 15	680	19.300
HDG-88R	12 - 18	980	22.400
HDG-110R	14 - 22	1.140	24.500
HDG-130R	15 - 24	1.220	25.300
HDG-150R	17 - 25	1.380	26.100
HDG-180R	18 - 28	1.520	27.400
HDG-210R	20 - 30	1.640	30.000
HDG-240R	22 - 32	1.830	32.600
HDG-280R	24 - 36	1.980	36.500
HDG-310R	25 - 38	2.030	39.100
HDG-340R	28 - 42	2.280	41.700
HDG-380R	30 - 45	2.840	49.500
HDG-420R	32 - 52	3.060	52.100
HDG-480R	35 - 54	3.420	54.700
HDG-520R	42 - 64	4.360	78.200
HDG-580R	45 - 80	4.700	91.200
HDG-640R	50 - 85	5.420	104.200
HDG-820R	80 - 140	8.120	182.300
HDG-1400R	120 - 140	14.200	312.600

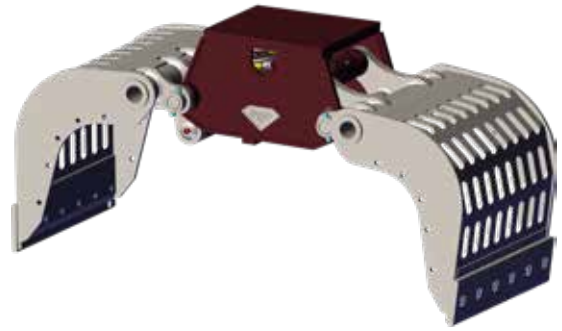

HDG-ZD SERIES

Demolition & sorting grabs
Abbruch & Sortiergreifer





Model	 T.	 KG	€ Euro
HDG-8ZD	0.6 - 1.0	70	5.200
HDG-10ZD	0.8 - 1.8	90	5.800
HDG-15ZD	1.0 - 2.5	150	7.300
HDG-25ZD	2.5 - 4.0	200	8.400
HDG-42ZD	4.0 - 6.0	280	9.400
HDG-46ZD	5.0 - 9.0	330	10.200
HDG-52ZD	7.0 - 11	380	10.400
HDG-62ZD	7.0 - 12	500	12.500
HDG-88ZD	10 - 16	600	13.000
HDG-110ZD	12 - 20	775	15.100
HDG-130ZD	13 - 20	785	15.400
HDG-150ZD	15 - 20	800	16.200
HDG-180ZD	16 - 25	1.100	19.800
HDG-210ZD	17 - 28	1.200	21.400
HDG-240ZD	20 - 28	1.300	23.500
HDG-310ZD	25 - 38	1.620	25.600
HDG-340ZD	25 - 38	1.880	26.100
HDG-380ZD	28 - 40	2.180	32.600
HDG-420ZD	30 - 50	2.480	35.200

HCB SERIES

Crushing buckets
Brecherlöffel



Model	 T.	 KG	€ Euro	Production
HCB-16	14 - 22	1.720	61.800	23 T./H
HCB-26	22 - 32	2.380	70.200	34 T./H
HCB-32	28 - 38	3.310	82.900	42 T./H
HCB-42	36 - 50	4.280	91.300	53 T./H
HCB-56	40 - 65	5.570	113.800	70 T./H





Kit

The magnetic separator kit contains: connecting bracket, screws and bolts, connector and electrical wiring.

Elektromagnet Kit erhält: Befestigungsbügel, Schrauben, Muttern, Elektrischer Schaltung und Kabel.

HCD SERIES



Car dismantlers
Auto-demontageschere

Model	 T.	 KG	€ Euro
HCD-15R	16 - 25	1.520	62.600



HMR SERIES



Multi-recycler

Model	 T.	 KG	€ Euro
HMR-15V	13 - 22	1480	47.800



HSB SERIES

Rotating screening buckets
Rotierende Sieblöffel

Model	 T.	 KG	€ Euro
HSB-200	1.5 - 2.5	165	7.400
HSB-300	3.0 - 5.0	300	10.700
HSB-400	5.0 - 8.0	420	13.500
HSB-700	8.0 - 12	755	18.800



Price without screen kits.
Preise zzgl. Siebeinsätze.

SCREENKITS - Steel plate / Stahlplatte

MM	Material	€ HSB-200	€ HSB-300	€ HSB-400	€ HSB-700
20x20	S355	200	400	700	800
30x30	S355	200	300	500	700
	Hardox	400	500	800	1.100
40x40	S355	200	300	500	600
	Hardox	300	400	700	1.000
50x50	S355	200	200	400	600
	Hardox	300	400	600	900
60x60	Hardox	300	300	500	800
70x70	Hardox	200	300	400	600
80x80	Hardox	*	300	400	600



SCREENKITS - Steel plate / Stahlplatte

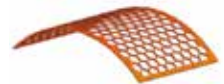

MM	Material	€ HSB-200	€ HSB-300	€ HSB-400	€ HSB-700
20x20	S355	800	1.100	1.700	2.500
30x30	S355	700	900	1.400	2.000
	Hardox	1.000	1.200	1.900	3.000
40x40	S355	600	700	1.100	1.700
	Hardox	800	1.000	1.400	2.500
50x50	S355	500	600	1.000	1.500
	Hardox	700	800	1.300	2.200
60x60	Hardox	500	700	1.100	1.900
70x70	Hardox	500	600	800	1.500
80x80	Hardox	-	500	800	1.400
90x90	Hardox	-	*	700	1.300
100x100	Hardox	-	*	*	1.200



* Available on request
* Verfügbar auf Anfrage

HSB SERIES

Rotating screening buckets
Rotierende Sieblöffel

Model	 T.	 KG	€ Euro
HSB-1400	13 - 16	1.380	28.500
HSB-1600	17 - 21	1.635	30.400
HSB-1900	22 - 30	1.875	32.600
HSB-2600	31 - 40	2.600	42.500
HSB-4900	41 - 55	4.955	86.900



Price without screen kits.
Preise zzgl. Siebeinsätze.

SCREENKITS - Steel plate / Stahlplatte

MM	Material	€ HSB-1400	€ HSB-1600	€ HSB-1900	€ HSB-2600	€ HSB-4900
20x20	S355	1.400	1.800	2.500	2.800	4.100
	Hardox	2.300	3.300	4.400	4.900	6.600
30x30	S355	1.200	1.600	2.000	2.200	3.900
	Hardox	1.700	2.300	3.000	3.200	4.600
40x40	S355	1.100	1.500	1.900	2.000	3.600
	Hardox	1.400	1.900	2.400	2.700	4.200
50x50	S355	1.000	1.300	1.800	1.900	5.500
	Hardox	1.200	1.600	2.200	2.300	6.100
60x60	Hardox	1.200	1.400	1.800	2.200	5.200
70x70	Hardox	1.000	1.200	1.500	1.700	4.400
80x80	Hardox	1.000	1.200	1.500	1.600	3.900
90x90	Hardox	1.000	1.000	1.300	2.000	3.500
100x100	Hardox	800	1.000	1.300	1.800	3.400
120x120	Hardox	800	1.000	1.400	1.700	3.300
150x150	Hardox	800	900	1.400	1.700	3.100

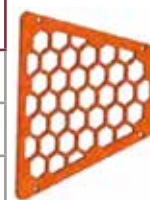

SCREENKITS - Steel plate / Stahlplatte

MM	Material	€ HSB-1400	€ HSB-1600	€ HSB-1900	€ HSB-2600	€ HSB-4900
20x20	S355	2.900	3.400	3.800	4.400	10.000
	Hardox	5.600	6.800	8.100	9.700	19.500
30x30	S355	2.400	2.700	3.200	4.000	8.300
	Hardox	3.800	4.700	5.300	6.400	13.100
40x40	S355	2.100	2.300	2.700	3.400	7.200
	Hardox	2.900	3.500	4.000	4.900	11.000
50x50	S355	1.800	2.100	2.400	2.900	12.400
	Hardox	2.600	3.000	3.400	4.200	15.800
60x60	Hardox	2.200	2.600	3.000	3.600	12.900
70x70	Hardox	2.000	2.200	2.600	3.000	11.400
80x80	Hardox	2.000	2.200	2.400	2.900	10.000
90x90	Hardox	1.800	2.000	2.300	3.300	9.100
100x100	Hardox	1.600	1.900	2.100	3.200	8.700
120x120	Hardox	1.600	1.900	2.300	3.200	8.500
150x150	Hardox	1.500	1.800	2.200	3.100	8.000



The perimetral kit consists of 4 pieces. Bottom side kit consists of 8 pieces.

*Wire mesh or steel plating kits of sizes other than those in this catalogue available upon request.



Kit perimetrale besteht aus 4 Teilen. Kit Bodenseite besteht aus 8 Teilen.

*Sätze Netz / Stahlplatte mit verschiedenen Abmessungen sind verfügbar auf Anfrage.

HVB SERIES

Vibrating screening buckets

Vibrations-Sieblöffel



Model	 T.	 KG	€ Euro
HVB-16HD	13 - 20	1.620	43.200
HVB-22HD	20 - 30	2.080	52.400
HVB-32HD	30 - 45	3.140	76.200
HVB-42HD	42 - 58	4.160	92.300



HC SERIES

Compactors

Rüttelplatten

Model	 T.	 KG	€ Euro
HC-180/2	2.0 - 3.5	160	14.700
HC-250/2	3.5 - 7.0	230	16.800
HC-420/2	6.0 - 10	400	20.300
HC-600/2	8.0 - 16	580	21.600
HC-900/2	15 - 28	850	24.300
HC-1200/2	22 - 36	950	32.300
HC-1500/2	24 - 38	1.150	36.200
HC-1800/2	25 - 40	1.650	65.000
HC-2200/2	28 - 48	2.200	83.000



Accessories:

Clamp for pile driving/ Spundwandklemme. HC-600/2 and up:

Flow and pressure regulator:

Mech. Rotation and top bracket:

Top bracket:

€ 16.000

Standard



Standard

Standard



HPC SERIES



Pile crackers
Pfählknacker

Model	 T.	 KG	€ Euro
HPC-350	13 - 24	1.200	52.900
HPC-500	16 - 26	1.650	70.000
HPC-600	16 - 26	1.780	71.400
HPC-700	18 - 30	1.840	77.400
HPC-900	18 - 30	2.050	84.000



HBG SERIES

Battery magnets
Batteriemagnete

Model	 T.	 KG	€ Euro
HBG-65	4 - 5	280	11.200
HBG-80	6 - 8	490	15.300
HBG-92	10 - 14	650	23.500



EMG SERIES

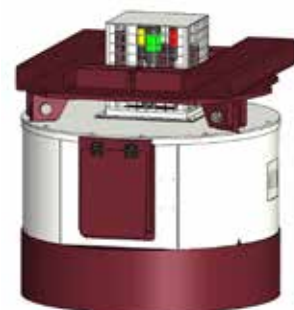

Battery integrated magnets
Magnete mit integrierter Batterie

Model	 KG	€ Euro
EMG-80	550	21.100
EMG-100	950	26.300



HEM SERIES



Electromagnets
Elektrische magnete

Model	 T.	 KG	€ Euro
HEM-80	8 - 10	480	11.900
HEM-95	11 - 14	650	13.000
HEM-105	13 - 16	750	16.800
HEM-115	14 - 18	850	18.800
HEM-125	20 - 24	1.150	19.600
HEM-145	29 - 36	1.700	24.600
HEM-150	34 - 42	2.000	28.700
HEM-160	43 - 54	2.700	35.100



HEM-HD SERIES



Electromagnets
Elektrische Schwerlastmagnete

Model	 T.	 KG	€ Euro
HEM-105HD	13 - 17	870	18.000
HEM-115HD	17 - 23	1.150	20.500
HEM-125HD	22 - 29	1.450	21.800
HEM-140HD	35 - 46	2.300	30.000
HEM-150HD	36 - 48	2.400	33.400
HEM-165HD	53 - 70	3.500	42.900
HEM-180HD	72 - 96	4.800	62.900



HMG SERIES

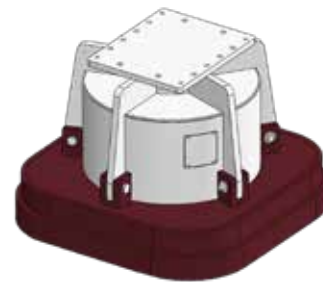

Hydraulic magnets
Hydraulische magnete

Model	 T.	 KG	€ Euro
HMG-850	10 - 16	780	36.300
HMG-950	14 - 20	960	38.300
HMG-1100	18 - 28	1.100	40.600
HMG-1150	20 - 30	1.200	42.100
HMG-1300	26 - 38	1.880	45.100
HMG-1500	30 - 60	2.500	68.600



HMG-T SERIES

Hydraulic magnets
Hydraulische magnete

Model	 T.	 KG	€ Euro
HMG-T850	10 - 16	950	37.100
HMG-T950	14 - 20	1.130	39.300
HMG-T1100	18 - 28	1.315	41.900
HMG-T1150	20 - 30	1.400	43.400
HMG-T1300	26 - 38	2.100	46.300
HMG-T1500	34 - 60	3.000	70.300

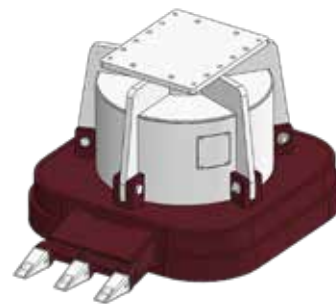

HS SERIES











Hydrasauger

Model	 KG	€ Euro
HS-5000	1375	36.850



HTR SERIES

Tree Cutters
Baumscheren

Model	 T.	 KG	€ Euro
HTR-13R	 *	1120	57.200
	 **	100	8.700
	 ***	750	41.500
HTR-17R	 *	1460	72.700
	 **	100	7.700
	 ***	910	56.300
HTR-23R	 *	1970	96.500
	 **	180	9.300
	 ***	1420	80.900





** Optional central accumulation clamp
** Optionale zentrale Sammelklemme

* The mentioned weight refers to grapple with HD rotation version
* Das angegebene Weight bezieht sich auf den Schere mit HD-Rotationsversion
*** Without rotation and without accumulation clamp
*** Ohne hydraulische Rotation und ohne Greifer zur Sammlung

HWS SERIES



Woodsplitter
Holzspalter

Model	 T.	 KG	€ Euro
HWS-200R	3 - 5	280	11.100
HWS-450R	6 - 8	395	18.900
HWS-750R	9 - 13	780	30.500
HWS-1100R	14 - 21	1320	43.900
HWS-1700R	22 - 30	2620	57.200



HSC SERIES



Stump cutter
Wurzelschere

Model	 T.	 KG	€ Euro
HSC-1100	13 - 18	1320	32.700
HSC-2200	18 - 25	2380	57.700



HTG SERIES



Tree Grabs
Baumgreifer

Model	 T.	 KG	€ Euro
HTG-15R	1.2 - 3	150	11.700
HTG-34R	3 - 5	220	14.400
HTG-42R	4 - 7	300	17.000
HTG-46R	5 - 8	350	17.200
HTG-52R	6 - 11	450	18.300
HTG-88R	10 - 16	800	22.900
HTG-110R	12 - 20	1000	25.600
HTG-180R	16 - 24	1140	28.700
HTG-210R	17 - 28	1580	33.900
HTG-310R	24 - 32	1810	40.400
HTG-340R	25 - 35	2050	44.300
HTG-420R	30 - 50	3480	62.500



HTG-T SERIES

Tree Grabs
Baumgreifer

Model	 T.	 KG	€ Euro
HTG-15RT*	1.5 - 4	160	13.000
HTG-34RT*	3 - 5	220	15.700
HTG-42RT*	4 - 7	320	18.300
HTG-46RT*	5 - 8	400	18.500
HTG-52RT*	6 - 11	500	19.600
HTG-88RT*	10 - 16	920	24.500
HTG-110RT*	12 - 20	1100	27.100
HTG-180RT*	16 - 25	1280	30.800
HTG-210RT*	20 - 30	1720	36.500
HTG-310RT*	20 - 30	1850	43.000
HTG-340RT*	25 - 35	2340	46.900
HTG-420RT*	32 - 55	3520	67.700





* T-version is equipped with 7 fingers
* T-version ist ausgestattet mit 7 Fingern



HTG-ZD SERIES



Tree Grabs without Rotation
Baumgreifer ohne Drehung

Model	 T.	 KG	€ Euro
HTG-15ZD	1.2 - 3	110	8.400
HTG-46ZD	5 - 8	280	11.500
HTG-52ZD	5 - 8	280	11.500
HTG-88ZD	10 - 16	560	14.100
HTG-110ZD	12 - 20	720	16.700
HTG-210ZD	17 - 28	1200	22.200



HTG-ZD T SERIES

Tree Grabs without Rotation
Baumgreifer ohne Drehung

Model	 T.	 KG	€ Euro
HTG-15ZD T	1.5 - 4	120	9.900
HTG-46ZD T	5 - 8	330	12.800
HTG-52ZD T	5 - 8	330	12.800
HTG-88ZD T	10 - 16	680	15.700
HTG-110ZD T	12 - 20	840	18.300
HTG-210ZD T	17 - 28	1400	24.000



*T-version is equipped with 7 fingers

*T-version ist ausgestattet mit 7 Fingers







MK-P SERIES



Multiprocessors
Multiprozessoren

POWERBOOSTER

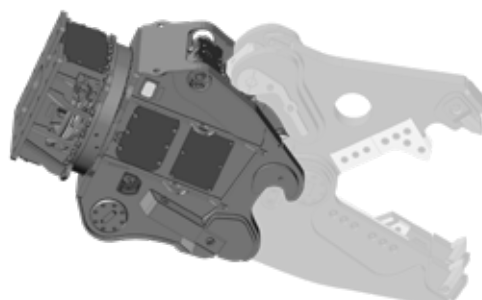

Model	 T.	 KG	€ Euro
MK-20P	18 - 25	1.335	70.200
MK-24P	25 - 35	1.520	78.100
MK-32P	35 - 45	2.015	89.700
MK-42P	45 - 60	2.390	103.400





Data refers to the body without jaw kit.
Daten bezogen auf das Gehäuse ohne Gebiß.

Pulverizer Jaw Pulverisierer Gebiß	Model	 KG	€ Euro
		MK-20P	780
MK-24P		1.000	30.500
MK-32P		1.425	36.500
MK-42P		1.880	43.700



P

Steel Jaw Stahl Gebiß	Model	 KG	€ Euro
		MK-20P	650
MK-24P		1.020	41.200
MK-32P		1.310	49.800
MK-42P		1.605	56.000

S

Combi Jaw Kombi Gebiß	Model	 KG	€ Euro
		MK-20P	760
MK-24P		1.185	40.700
MK-32P		1.400	49.100
MK-42P		1.900	55.100

C

Demolition Jaw Abbruch Gebiß	Model	 KG	€ Euro
		MK-20P	720
MK-24P		1.160	35.400
MK-32P		1.350	43.700
MK-42P		1.820	-



D

POWERBOOSTER

HCC-P SERIES

Concrete Crushers
Betonzangen

POWERBOOSTER



Model	 T.	 KG	€ Euro
HCC-18P	16 - 23	1.900	84.100
HCC-24P	24 - 32	2.500	99.200
HCC-31P	33 - 40	3.100	136.700
HCC-46P	41 - 56	4.680	176.700



HFP-P SERIES

Fixed pulverizers
Pulverisierer Star

POWERBOOSTER



Model	 T.	 KG	€ Euro
HFP-15P	13 - 17	1.480	58.200
HFP-21P	18 - 25	2.170	73.200
HFP-26PR	23 - 28	2.680	90.400
HFP-30P	25 - 32	2.880	81.500
HFP-33PR	33 - 45	3.490	105.700
HFP-36P	33 - 45	3.660	101.100



HRP-P SERIES

Rotating pulverizers
Drehbare Pulverisierer

POWERBOOSTER

Model	 T.	 KG	€ Euro
HRP-22P	16 - 21	2.230	82.700
HRP-27P	22 - 28	2.780	91.900
HRP-35P	29 - 35	3.460	106.000
HRP-43P	36 - 50	4.300	128.000

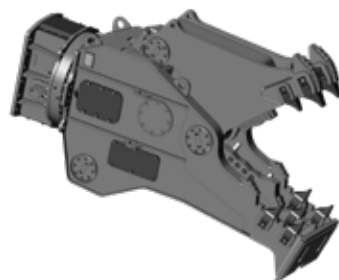



HYDRARAM. WE BRING THE MUSCLE

Hydraram has been developing and producing hydraulic attachments for use in demolition & recycling industry since 1993. We supply a complete line of hydraulic attachments for excavators from 1 to 300 tons.



HYDRARAM B.V.

Meander 7
9231 DB Surhuisterveen
The Netherlands
Tel: +31 (0)512-365981
E-mail: Info@hydraram.com
Web: www.hydraram.com

HYDRARAM Deutschland GmbH

Ernst Thälmanstraße 16
15518 Steinhöfel OT Heinersdorf
Germany
Tel: +49 (0)33432-746133
E-mail: Info@hydraram.de
Web: www.hydraram.de

The selling prices are excl. VAT and other taxes/charges and ex Works.
Pricing and product availability are subject to change without notice.

Alle Preise verstehen sich netto zzgl. der gesetzlichen MwSt und ab Werk.
Änderungen von Preise. Konstruktionen und Ausstattungen vorbehalten.