



Engine	Cummins B4.5, Stage V
Rated Power	115 kW (154 hp / 156 ps) @ 2,200 rpm
Net Power	106 kW (142 hp / 144 ps) @ 2,200 rpm
Operating Weight	12,725 kg (28,054 lbs)
Standard Bucket Size	1.9 m ³ (2.5 yd ³)
Standard Breakout Force	121 kN (27,202 lbf)
Standard Dump Clearance	2,730 mm (8'11.48")

835H WHEEL LOADER

TOUGH WORLD. TOUGH EQUIPMENT.

You don't need to be told it's a tough world. It's your reality, you live it every day and you know how hard it can be on your people and your machines. It's getting tougher to make your business pay too, with rising costs, increasing legislation and greater competition. We understand and we've put that insight into action with a choice of two, new middle weight wheel loaders: the new 835H . Our aim is to give you powerful, adaptable machines to bring real, multi-tasking benefits to the jobsite.

NO TOUGH COMPROMISES, JUST EVERYTHING YOU NEED AND NOTHING YOU DON'T

The construction equipment industry has seen an expensive trend towards over-engineered products. Some manufacturers genuinely believe that adding cost, adds perceived value in customers' eyes.

BUT YOU TOLD US A DIFFERENT STORY

You asked for tough, well-engineered wheel loaders, with the ability to adapt to any situation and handle multiple jobs with ease.

YOU WANTED HARD WORKING WHEEL LOADERS THAT DELIVER ON 3 ESSENTIAL NEEDS:

1



JOBSITE ADAPTABILITY

2



UPTIME AND SUPPORT

3



TOTAL COST OF OWNERSHIP



With the new 835H, we've risen to your challenge and given you everything you want – a choice of tough, multi-tasking, versatile wheel loaders – built without compromise.



TOUGH FACTS

AWARD WINNING DESIGN

Our UK-based design team has invested thousands of man hours to really understand how our machines are used every day. This insight shapes our innovative approach to product design. Our design team recently won a prestigious Red Dot Award for our D-Series Grader and all our products this award-winning design DNA.

TOUGH RESEARCH AND TESTING

Finding tougher, smarter, safer and more cost-effective ways of working matters to you. It matters to us too. Our new Global Research & Development Centre is a great example of this customer focused approach. We've established an international team of industry experts, backed up with the latest world-class technology, all focused on delivering greater value to you.

TOUGH QUALITY STANDARDS

When it comes to quality, we let our actions to speak for themselves.

We follow a rigorous Six Sigma methodology and consistently achieve ISO 9001 standards.

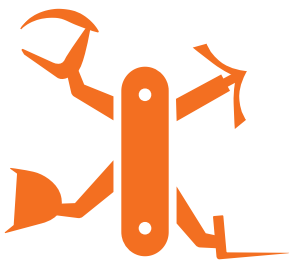

JOBSITE ADAPTABILITY

To ensure real return on investment you demand machines that can quickly adapt to any situation on the jobsite and handle multiple jobs with speed and precision. Our new 835H wheel loader combined with our perfectly matched quick coupler and attachments, create the ultimate in multi-tools.

Here is a selection of key benefits, common to both of our new machines.

1 POWER TO WORK HARDER

Our new wheel loaders match their power to the job with world-class, versatile engines, designed to maximize torque and deliver more power and breakout force at lower engine speeds.

2 TRANSMISSION EFFICIENCY

The new 4-speed ZF power shift transmission, including torque converter, cleverly adapts to any situation, ensuring the maximum transfer of power to improve performance and fuel efficiency.

3 ADAPTIVE HYDRAULICS

LiuGong's new-generation advanced hydraulic system adapts itself to any job organizing the mechanical, electrical and hydraulic systems to work in perfect harmony. Power is supplied only as needed, achieving optimum operation, whatever the application.

4 TOTAL CONTROL

Multiple tasks require total control. The kick-down and forward/reverse buttons are conveniently located on the loader joystick, putting absolute control right where it belongs - in the operator's hands.



5 NEW Z-BAR LINKAGE

Optimized Z-Bar geometry further improves the adaptability of our machines enhancing bucket breakout force, loading stability, speed and operator visibility.

6 GET A GRIP

For the ultimate in traction and manoeuvrability, you can rely on our limited-slip differential axles. They automatically deliver power to the wheels making turning easier, reducing tire wear and maximizing bucket-filling performance.

7 THE TOUGHEST FRAME

The chassis frame is the backbone of the machine, so it's got to be tough. Our rigorous design and testing regime has delivered a chassis capable of absorbing all the forces and pressures of the toughest environments and most demanding jobs. Year after year, our chassis stays strong, protecting the driveline, your operator and your profitability.

8 THE PERFECT MATCH

Jobsite adaptability is about perfectly matching the machine to a wide range of attachments. We've created a versatile tool that will maximize productivity and return on investment.

9 GETS THE JOB DONE SAFELY

When it comes to safety our cabs are second to none. ROPS and FOPS safeguard your operator, but we've gone further by enhancing visibility to create a safer environment inside and outside the cab.



TOUGH JUDGES

Wheel loader operators are tough judges. They know what they like and what they don't. We've talked, we've listened and we've delivered a no-nonsense wheel loader that will do everything the operator wants and needs it to do.

Job done? Judge for yourself.

500,000

SHARING OUR CUSTOMERS' SUCCESS

No matter what we say or how passionately we argue our case, ultimately jobsite adaptability comes down to one unavoidable question.

Can our machines really cut it in the real world?

Our answer?

Ask the satisfied owners of the **500,000** LiuGong wheel loaders already delivered. Their trust in our knowledge, their satisfaction in our product and their loyalty, have made LiuGong one of the world's largest wheel loader manufacturers.

Don't take our word... take theirs.



MACHINES DELIVERED

“ GETS THE JOB DONE

I have been the operator of this LiuGong wheel loader since the company purchased it three years ago... It is used day in, day out, eight-to-ten hours a day, five and sometimes six days a week. Even though stone mines are tough on machinery we have not had any major problems. Age has not effected the controls; they are still just as reactive and the engine and lifting performance is still as strong as the day it arrived. ”

Eszak Terko Ltd – Hungary

“ A CREDIBLE CHOICE

Even though we know that Chinese brands will be future leaders in the construction industry, we were a little uncertain about what LiuGong could offer, so we did a lot of research online before committing to the purchase. We found that LiuGong is a major player globally and that most of the technical components are from Western Europe so there is very little risk.

If we do have a problem, there is a European parts warehouse in Poland and the local dealer provides good support.

Van Dijk Infragroep – the Netherlands

”

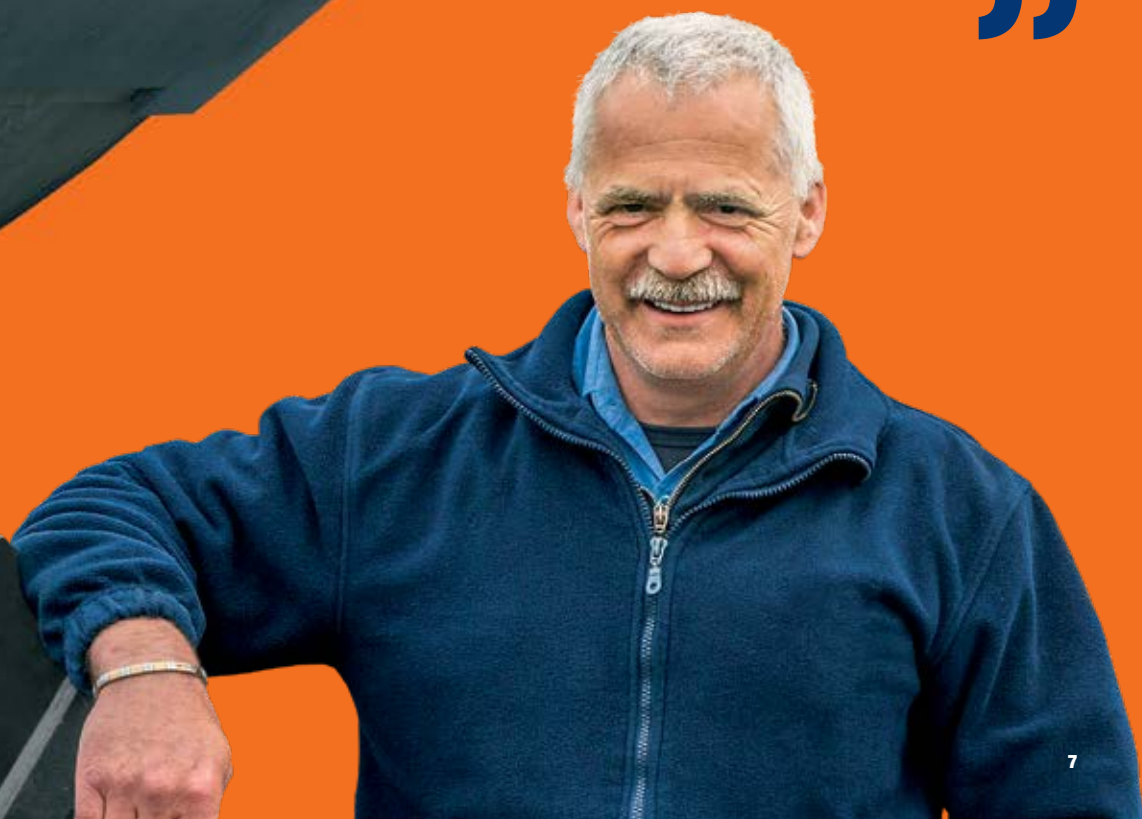

POWERED TO PERFORM

Jobsite adaptability is about giving you the power to get more productivity from your machine, but for less cost and less environmental impact.



LESS IS MORE

At the heart of our brand new 835H beats world-leading engine technology from Cummins. The engine has been carefully chosen to help deliver operational versatility, reduce cost and to comply with the latest environmental legislation.

The engine uses a precise, high pressure common-rail fuel injection system, smart wastegate turbo and air-to-air intercooler combining to deliver optimal performance whatever the task.

Integrated post-processing system(DOC+DPF+SCR) achieves Stage V emissions regulations .

But we go even further to reduce environmental impact and boost your bottom line.

Our engine is optimized for rapid throttle response, getting the job done fast, but not at the expense of the environment. Fuel consumption and emission are significantly reduced with Intelligent Auto-Idle Speed Control. This smart function matches the engine speed and RPM to the task, automatically switching to idle speed

between actions. Tests indicate that a significant amount of fuel (2-3 L) can be saved on a typical 8 hour shift.

Our engine may be green but they don't compromise on toughness. Endurance testing exposes it to over 30,000 hours of relentless testing, proving that our machines really do have the power to perform, shift after shift.

KEEPING IT COOL AND CLEAN

Inefficient engine cooling has a negative effect on fuel economy and emissions. We have focused our design experience on greatly improving the engine cooling system. The new 6mm hexagon grill improves ventilation while a new reversible hydraulic fan, increases cooling efficiency with the flick of a button.



Cummins B4.5

4-cylinder, 4.5 liter, turbocharged, common-rail
Net power rating of 106 kW (142 hp) @ 2,200 rpm.



TRANSMISSION EFFICIENCY

Our new 835H offers 4 speeds forward (4F) and 3 speeds reverse (3R).

The new 4-speed ZF power shift transmission, , cleverly adapts to any situation, ensuring the maximum transfer of power to the transmission for improved performance and fuel efficiency.

Optimized gear ratios and auto-shift functionality provide faster acceleration and faster cycle times, regardless of the application. Kick-down and Forward/Reverse buttons are conveniently located on the loader joystick for efficient operator/machine interface, further reducing cycle times and improving production and efficiency.

DESIGNED TO GET MORE DONE

Jobsite adaptability is about giving you more options to take on multiple tasks and to achieve higher return on your investment.



LOCKED ON VERSATILITY

Our ISO 23727 compliant quick coupler lives up to its name and turns your wheel loader into a powerful multi-functional tool in seconds. It allows your operators to select, lock on and utilize attachments quickly and safely from the comfort of the cab, helping you do more and earn more.

NEW Z-BAR LINKAGE

Careful distribution of stress loads increases the Z-bar's tolerance significantly. Improved Z-bar geometry enhances bucket breakout force, operator visibility, loading stability and speed.

ADVANCED LOAD SENSING HYDRAULICS

LiuGong's new-generation advanced hydraulic system adapts itself to any job, organizing the mechanical, electrical and hydraulic systems to work in perfect harmony.

Adaptive technology perfectly matches the hydraulic flow with the machine's operation. Power is only supplied as needed, ensuring superior control of both the boom and the attachment enabling the operator to complete a variety of demanding tasks with precision and efficiency.



POWERFUL TRACTION

Limited-slip differential front axle and conventional rear match themselves to the toughest terrain, automatically delivering power to all four tires and increasing traction for maximized bucket-filling performance. Advanced axle engineering increases the resistance to both internal torque loads and the external forces helping to get tough work done easily.

RIDE CONTROL

LiuGong wheel loaders excel in adapting to any jobsite conditions. Our new generation ride control, coupled with an automated bucket positioning feature, absorbs shocks and improves ride quality for the operator over any terrain. Importantly, our new ride control significantly prevents material loss and perfectly complements our new buckets which are easier to fill, load and carry, noticeably increasing productivity and earning potential.



COMFORT AND SAFETY. NO COMPROMISES

Climb into our cabs and you can see that they have been designed by someone who has operated a machine in really tough conditions and who knows the importance of comfort and safety.

For a start, 3-Bar stamped steps with a 10° ergonomic incline and improved anti-slip tread make our machines safe and easy to get in and out of.

Well-placed door handles, safety rails and anti-slip tape on the upper part of the machine make it easier and safer for operators to enter and exit the cab safely in all weathers and conditions.

Superior visibility is essential for safe and productive work on the jobsite, particularly when working in a confined space or when switching multiple attachments. We've risen to the visibility challenge by creating a panoramic view cab with curved front glass and well positioned lift arms to guarantee the operator a clear line of sight to the bucket edge at ground level. Sight lines to all corners of the machine have also been improved to increase safety whilst the optional rear-view camera contributes to an

overall visibility improvement of 15%.

The controls, including joystick or finger control levers, are where the operator needs them to be. They are easy to see, easy to reach and easy to handle.

The multi-adjustable air-suspension seats are comfortable and designed to keep the operator fresh and alert.

WE PUT OPERATORS FIRST

It makes good business sense to give operators the very best working environment – a comfortable operator is a productive operator.

Our aim is to keep operators safer, more alert and more productive.

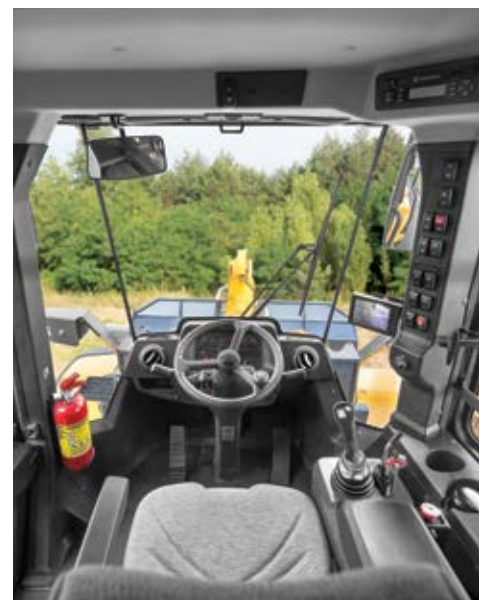

The cab protects the operator from noise and vibrations and is well ventilated. It has advanced climate control to handle the changing seasons and is completely sealed to prevent dust from entering the workplace.

HARD WORK – NO SWEAT

Whatever the job, an advanced climate control system with eight all-round vents, creates the perfect working environment in any weather. Easy-to-replace air filters further enhance the operator's experience eliminating dust and preventing particles from polluting the cab.

CONTROL IN THE OPERATOR'S HANDS

We believe in making life easy for the operator which is why we've positioned the kick-down and forward/reverse buttons on the joystick.

The kick-down function gives the operator finger-tip control enabling him to lower the gear, increase engine torque and maximize bucket breakout force with the minimum of effort.



DAILY CHECKS AND MAINTENANCE SHOULDN'T BE TOUGH

Simple daily checks and maintenance prolong machine performance but, they can be difficult and time consuming on tough jobsites where time is precious.

Not with our wheel loaders.

The wide opening fiberglass hood gives fast and easy access to the engine and regular service points – that's good news for operators who want to reduce maintenance time to the minimum.

ONBOARD MONITORING

With on board monitoring, the operator can check the machine's vital signs; oil temperatures and pressure levels, receive service interval alerts and access all the information that contributes to simple maintenance and servicing of the machine, right from his seat.



Maintenance speed and access is further improved with sturdy handrails, fitted as standard, which enable safe and easy access to the upper structure.



An optional, automatic greasing system improves bearing life and reduces repairs by delivering regular and precise amounts of grease to each bearing.

EASILY ACCESSIBLE SERVICE POINTS MAKE DAILY CHECKS FAST AND EFFECTIVE

- Easily visible hydraulic oil level gauge
- Ground accessible, grouped filters
- Easy to reach electronic control box
- Easy to replace A/C filter next to the cab door





JOBSITE UPTIME AND SUPPORT

Heavyweight credibility might convince you to buy your first machine, but it's uptime and support and total cost of ownership which will keep you coming back to buy more machines. Having confidence in the machine's back up and support network is a vital part of the purchasing decision. How do we at LiuGong measure up?

FAST RESPONDING GLOBAL NETWORK

We have an extensive dealer network of over 300 dealers in more than 100 countries.

All supported by 13 regional subsidiaries and 17 regional parts depots offering expert training, parts and service support.



WE ARE LIUGONG. WORKING HARD TO KEEP OUR GLOBAL CUSTOMERS EARNING

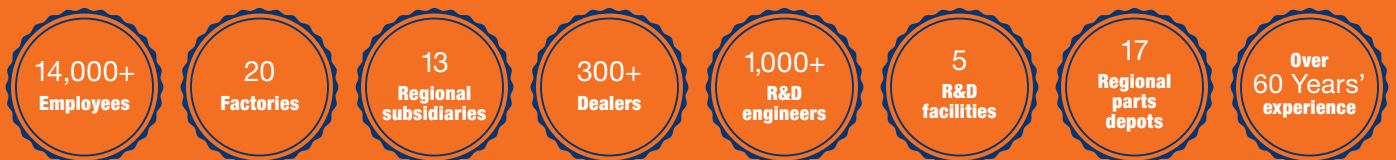

WHERE YOU NEED US WHEN YOU NEED US

Reliability is built into our machines but all machines have some planned downtime. Our aim is to reduce even planned down time to the minimum by getting it right.

Technician training and parts availability are also high on our agenda, as is keeping you

informed on service and maintenance work and providing clear and accurate estimates, invoices and communication.

These may be small things, but customer feedback tells us that these basics really matter – so we aim to get them right.

MAINTENANCE AND SUPPORT PACKAGES

From genuine LiuGong parts, to full repair and maintenance contracts, LiuGong has the flexibility to offer the level of support and response to suit your business and applications. Whatever level of support you choose you can be confident that it is backed up by LiuGong's service promise.



**Right parts.
Right price.
Right service.**

**Above all,
we get it right
the first time.**

1st



LIUGONG SERVICE PROMISE



Highly trained technicians
utilizing the latest
diagnostic equipment



15,000+ Genuine LiuGong
parts available within 24hrs
from our European Parts
Distribution Center



Multi-lingual service helpline
and online support



Transparent estimates
and invoicing



Clear communications through
electronic parts catalogue



TOTAL COST OF OWNERSHIP

Jobsite adaptability and uptime & support are two key wheel loader purchasing criteria but ultimately, the machine's earning potential, its overall life cost and its trade-in value really matter too.

When it comes to total cost of ownership LiuGong has a strong story to tell.

PROFESSIONAL ADVICE

We are committed to reducing your total cost of ownership and increasing your profits. As part of this, LiuGong's experts will provide targeted advice on everything, from choosing the right machine for your needs to maximizing its efficiency on site.

MACHINE AVAILABILITY

Our machines deliver everything you need and nothing you don't. They are expertly engineered NOT over engineered. As a result of having an extensive manufacturing operation right in the heart of Europe, we can offer significantly shorter lead times on

a range of models, compared with some manufacturers. In fact, we can deliver selected machines in as little as 4 weeks.

The faster you can get a machine – the faster you can get working and earning.

Our aim is to get you on to the jobsite fast.

TICKET PRICE

At LiuGong, our aim is to provide you with real, measurable value by giving you everything you need and nothing you don't. For example, we choose high quality, proven components such as Cummins/ Perkins engines and Rexroth hydraulic pumps. These proven components, combined with LiuGong design and manufacturing quality, result in a high quality, competitive machine that is totally fit for purpose.

RESIDUAL VALUE

With the combination of LiuGong design and manufacturing excellence, world class components and comprehensive uptime support, our quality holds its value.





IT ALL ADDS UP

With our new wheel loaders we've risen to the challenge and given you everything you need and nothing you don't.

They can handle any job, anywhere and are backed up by LiuGong's service promise. Add up the benefits and you'll see that our new 835H have the formula for success.



JOBSITE ADAPTABILITY

+

**UPTIME AND
SUPPORT**

+

**TOTAL COST
OF OWNERSHIP**

CUSTOMER SATISFACTION

Operating weight 12,725 kg (28,054 lbs)

Operating weight includes the machine weight with standard work device, no additional equipment or accessories, full fuel tank, all fluids at required level and an operator 75 kg (165 lbs).

Bucket capacity 1.8 - 4 m³
(2.5 - 5.2 yd³)**ENGINE****Description**

Cummins EU Stage V, 4.4 liter (1.2 gal), 4-cylinder straight turbocharged diesel engine with Common Rail fuel injection system. Single stage turbocharger with Smart Wastegate. Integrated post-processing system (DOC+DPF+SCR) achieves Stage V emissions regulations. Particulate emissions are reduced during combustion. Air cleaning: Direct flow air filter. Cooling system: Air-to-air intercooler, hydraulic motor drive and temperature controlled fan.

Emission rating	EU Stage V
Make	Cummins
Model	B4.5
Engine Output - Max Gross (SAE J1995 / ISO 14396)	115 kW (154 hp) @ 2,200 rpm
Engine Output - Max Net (SAE J1349 / ISO 9249)	106 kW (142 hp) @ 2,200 rpm
Peak torque	712 N·m (525.1 lbf·ft)
Displacement	4.5 L (1.2 gal)
Number of cylinders	4
Aspiration	Turbocharged & air-to-air intercooled

TRANSMISSION**Description**

Torque converter: single-stage, three elements.
Transmission: ZF 4BP190 ergo power countershaft transmission, integrated pilot single joystick with FNR, KD & horn.
Gearshifting system: ZF Automatic Power Shift with auto modes (1~4/2~4) all start in gear 2, faster and better for long distance material transport.

Transmission type	Countershaft, power shift
Torque converter	Single stage, three elements
Maximum travel speed, fwd	38 km/h (23.9 mph)
Maximum travel speed, rev	13,9 km/h (8,6 mph)
Number of speed, fwd	4
Number of speed, rev	3

HYDRAULIC SYSTEM**Description**

System supply: Single load-sensing axial piston pumps with variable displacement. The steering function always has priority.

Valves: Double-acting 3-spool valve. The main valve is controlled by a 3-spool pilot valve.

Lift function: The valve has four positions: lift, hold, lower, and float. Inductive/magnetic automatic boom kick-out can be switched on and off and is adjustable to two positions: bucket at ground level and maximum reach full lifting height.

Tilt function: The valve has three functions: rollback, hold and dump.

Cylinders: Double-acting cylinders for all functions.

Filter: Full-flow filtration through 12 micron (absolute) filter cartridge.

Main pump type	Piston
Main relief pressure	26 MPa (3,771 psi)
Raise	4.8 s
Dump time	1.1 s
Float down time	3.1 s
Fastest total cycle time	9.0 s
Controls	Pilot electric control

AXLES

Model	LiuGong (Wet type)
Differential front type	Limited slip
Differential rear type	Conventional
Axle oscillation	±12°

STEERING**Description**

Steering system: Load-sensing hydraulic articulated steering.

System supply: The steering system has priority feed from a load-sensing axial piston pump with variable displacement.

Steering cylinders: Two double-acting cylinders.

Steering configuration	Articulated
Steering relief pressure	18 MPa (2,611 psi)
Steering cylinders	2
Cylinder bore	80 mm (3.2")
Rod diameter	45 mm (1.8")
Stroke	420 mm (1'4")
Maximum flow	210 L/min (55.5 gal/min)
Maximum articulation	±40°
Smallest turn (over tire)	5,313 mm (17'5")

BRAKES**Description**

Two independent brake circuits, disks out of rim, accurate control with the advanced main valve & piston pump

Service brake type	Wet discs brake
Service brake actuation	Hydraulic
Parking brake type	Manual electronic control
Parking brake actuation	Hydraulic

ELECTRICAL SYSTEM

Description

Central warning system is a centralized electrical system with central warning light and buzzer for following functions: Serious engine fault, Low steering system pressure, Interruption in communication (computer failure), Low engine oil pressure, High engine oil temperature, High charge-air temperature, Low coolant level, High coolant temperature, Low transmission oil pressure, High transmission oil temperature, Low brake pressure, Engaged parking brake, Brake charging failure, High hydraulic oil temperature.

Voltage	24 V
Batteries	2 x 12 V
Battery capacity	2 x 55 Ah
Cold cranking capacity, approx	850 A
Reserve capacity	110 min
Alternator rating	2.3kW/95A
Starter motor output	4.8 kW (6.4 hp)

SERVICE REFILL CAPACITIES

Fuel tank	217 L (57.3 gal)
Engine oil	11.6 L (3 gal)
Cooling system	28 L (7.4 gal)
Hydraulic system	125 L (33 gal)
Transmission and torque converter	40 L (10.5 gal)
Axles, each	34 L (9 gal)
DEF Tank	15 L (4 gal)

SOUND & ENVIRONMENT

Sound level in cab according to ISO 6396-2008/EN ISO 3744-1995	70 dB(A)-- Travel mode
Sound level in cab according to ISO 6396-2008/EN ISO 3744-1995	70 dB(A)-- Stationary work cycle mode
External sound level according to ISO 6395-2008	104 dB(A)-- Travel mode
External sound level according to ISO 6395-2008	104 dB(A)-- Stationary work cycle mode
Ventilation	79 m ³ /min (103 yd ³ /min)
Heating capacity	5.8 kW (7.8 hp)
Air conditioning	5.0 kW (6.7 hp)

DIMENSIONS

E Ground clearance	400 mm (1' 1")
G Wheelbase	2,940 mm (9' 7")
H Cab height	3,370 mm (11'16")
J Wheel tread	1,910 mm (6' 3")
K Width over tires	2,355 mm (7'8")
L Length with bucket down	7,347 mm (24'1")
M Turn angle, either side	40°
P Rear angle of departure	31°
R ₁ Turning radius, bucket carry	5,807 mm (19'1")
R ₂ Turning radius, outside of tire	5,313 mm (17'5")

LOADER ARM PERFORMANCE WITH ATTACHMENT

Description

Tipping Load data is calculated with standard bucket at 1.9 m³ (2.5 yd³) and operating weight at 12,725 kg (28,054 lbs).

Tipping load – straight	8,855 kg (19,522 lb)
Tipping load – full turn	7,475 kg (16,480 lb)
Bucket breakout force	121 kN (27,202 lbf)
A Maximum hinge pin height	3,738 mm (12'3")
B Dump clearance at full height discharge	2,730mm (8'11.5")
C Dump reach at full height discharge	1,102 mm (3'7.5")
D Maximum digging depth, bucket level	60 mm (2.4")
S ₁ Bucket rollback at ground level	42°
S ₂ Bucket rollback at carry	49°
S ₃ Bucket rollback at maximum height	56°
S ₄ Maximum dump angle at full height	45°

CAB

Description

Instrumentation: All important information is centrally located in the central instrument panel and operator's field of vision.

Large curved front glass, rear view camera and mirrors ensure great visibility.

Adjustable steering column, air suspension seat, armrest box, and Denso A/C with all-around air outlets.



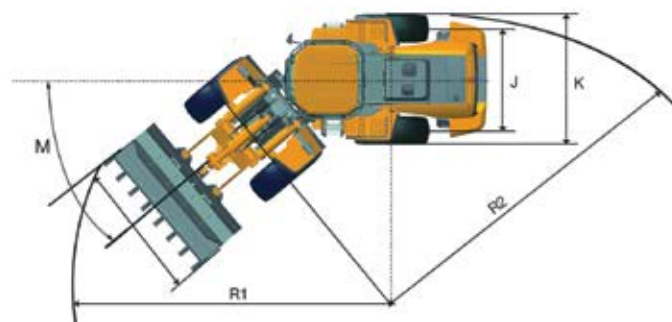
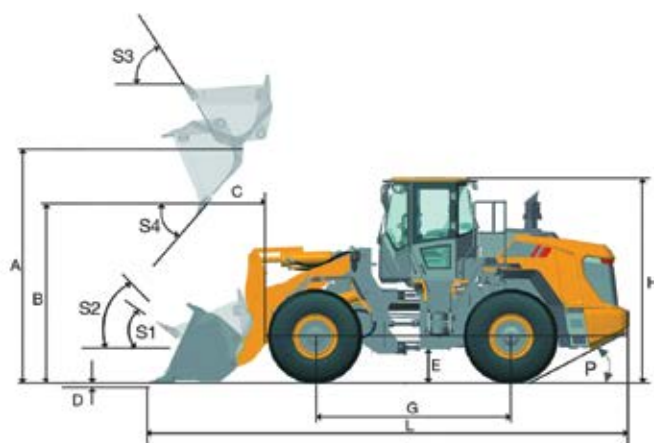

Pressurized cab with lower interior noise.

The cab is tested and approved according to ROPS (ISO 3471), FOPS (ISO 3449).



TIRES







Choosing the right tyres for your machine will become a key competitive advantage to achieve outstanding performance. Through close engineering and development cooperation with renowned and carefully selected suppliers, LiuGong can offer full range of tyres specially tailored for wheel loader.

Code	Application	Patterns	Size	PR / *	Tube Type	Width	Overall Diameter	Tread Depth	Load Capacity
L3	<ul style="list-style-type: none"> In sand operation In all kind of load/carry operation The L3-tread is not as open as L2 and has consequently less self-cleansing compared with an L2 tyre 		17.5 R 25	12	TT	445 mm (1'6")	1,350 mm (4'5")	26 mm (1.0")	3,650 / 6,150 kg (8,047 / 13,558 lbs)
			17.5 R 25	*	TL	445 mm (1'6")	1,345 mm (4'5")	29 mm (1.1")	7,100 / 4,125 kg (15,653 / 9,094 lbs)
			20.5 R 25	*	TL	520 mm (1'9")	1,490 mm (4'10")	28.5 mm (1.1")	5,600 / 9,500 kg (50 / 10 km/h) (12,346 / 9,094 lbs) (31.1 / 6.2 mph)
Solid Tire	Safe, durable, puncture-resistant, economical, maintenance-free, easy to operate in generally smooth roads, short-distance operation		17.5 R 25	/	Solid Tire	440 mm (1'6")	1,350 mm (4'5")	/	8,000 / 8,800 kg (25 km/h/ 10 km/h) (17,637 / 19,401 lbs) (15.5 / 6.2 mph)

Note: The radial tire-load bearing capacity is indicated by the number of stars (*). More stars, greater radial tire-load bearing capacity. For the specific radial tire sizes listed in the table above, 2 stars (**) represents the maximum radial tire-load bearing capacity.

ATTACHMENTS

LiuGong attachments with pin-on or quick-coupler ensure high quality. The integrated design of the system creates a perfect match to achieve superior productivity.

Type	Capacity	Width	Height	Digging Depth	Dump Clearance	Dump Reach	Description	Attachment Drawing
General Purpose	1.8 m ³ (2.4 yd ³)	2,500 mm (8'2")	1,196 mm (3'11")	60 mm (2.3") (17.5R)	2,733 mm (8'10")	1,154 mm (3'9")	Bolt-on Teeth.	
	1.9 m ³ (2.5 yd ³)	2,500 mm (8'2")	1,196 mm (3'11")		2,680 mm (8'9")	1,168 mm (3'10")	Bolt-on Cutting Edge; Bolt-on Teeth;	
	2.1 m ³ (2.8 yd ³)	2,740 mm (8'12")	1,237 mm (4'1")	20 mm (0.8") (20.5R)	2,632 mm (8'8")	1,255 mm (4'1")	Bolt-on Teeth.	
	2.3 m ³ (3.0 yd ³)	2,740 mm (8'12")	1,237 mm (4'1")		2,632 mm (8'8")	1,255 mm (4'1")	Bolt-on Cutting Edge.	
Light Material	4.0 m ³ (5.2 yd ³)	2,920 mm (9'7")	1,436 mm (4'8")		2,379 mm (7'10")	1,403 mm (4'7")	Bolt-on Cutting Edge.	
Grapple	Φ300 mm (1'1")	2,315 mm (7'7")	1,202 mm (3'11")	/	2,674 mm (8'9")	1,251 mm (4'1")	Crossed Teeth.	

LiuGong standard and optional equipment may vary from region to region. Please consult your LiuGong dealer for information specific to your area.



STANDARD EQUIPMENT

ENGINE

- Cummins EU Stage V, air-to-air intercooled, 4 cylinders, 4 stroke, reverse fan cooling
- High Pressure Common Rail
- Exhaust emission control
- DC air filter, fuel filter

TRANSMISSION

- ZF 4BP190 power shift transmission
- Kick-down function, FNR, F4/R3
- Transmission oil level sight gauge
- Secondary oil filter, oil stick
- Remote pressure taps for diagnostics
- Auto shifting mode by speed
- Interlock between parking brake and gear shifting

AXLE

- LiuGong wet front axle with limited slip differentials
- Wet discs service brake system
- Parking brake service as secondary

HYDRAULIC SYSTEM

- Single piston pumps with variable displacement hydraulic load-sensing
- Third valve and multipurpose lines
- Single joystick control
- Boom kick-out, automatic
- Bucket positioner, automatic
- Plug at the port of bucket and boom cylinder for pressure check
- Emergency boom lower via pilot accumulator

STEERING SYSTEM

- Load sensing system with flow amplification and steering priority
- Emergency steering system

TIRE & RIM

- 17.5-25/L3 Radial tire
- Full fender

CHASSIS FRAME

- Spacious central articulation arrangement with conic bearing
- Articulation locking bar
- Tow hitch
- Rubber cushion articulation stops

LINKAGE & ATTACHMENTS

- Z-bar linkage

ELECTRIC SYSTEM

- Two front lights with high/low beam
- Four front headlights on top of cab
- Four rear headlight on top of cab
- Turn signals with flasher
- Batteries, free of maintenance
- Cigarette lighter, 24 V power outlet
- Electric horn
- Front and rear windshield wiper
- Electronic device compartment
- Back-up alarm
- Radio/player with USB port
- Reversing warning light, automatic
- Rotating beacon
- License-plate bracket and light

GAUGE GROUP

- Engine coolant temperature
- Transmission oil temperature
- Fuel level
- Hour meter
- Voltage
- Brake oil pressure
- DEF Pump working indicator

INDICATOR GROUP

- Air inlet heater
- Battery charging
- Parking brake applied
- Machine emergency stop
- Power cut-off
- Engine servicing
- Turning lights
- Engine starter running
- Beam of front light

CAB

- Certified FOPS (ISO 3449) and ROPS (ISO 3471) cab
- Seat – mechanical suspension with 3 inch seatbelt
- 4-way adjustable steering column
- Large curved front glass
- Rubber cab mounts
- Cab fresh air filter
- One interior & dual exterior rear-view mirrors
- Rear-view camera display
- Air conditioner
- Lunch-box/cooler holder
- One beverage holder
- Cigarette lighter
- Cab rear window defroster
- Sun visors
- Fire extinguisher

OTHERS

- Automatic central lubrication
- Wedge block

OPTIONAL EQUIPMENT

ENGINE

- Cold start aid

HYDRAULIC SYSTEM

- Ride control

TIRE & RIM

- See tires options
- Normal fender
- Tire protective chain

CAB

- Heated air suspension seat
- Heated external rear view mirrors
- Cab dust removal device
- Front windshield screen (must be mounted at factory)

LINKAGE & ATTACHMENTS

- Quick coupler
- Additional counterweight
- Bolt-on wear-resist blade and teeth
- Rock bucket

- High lift arm
- Grapple with aligned or crossed teeth
- Fork
- Snow blade

OTHERS

- T-BOX Telematics
- Weight scale (Electric load weigher)
- Hood protective guard



TRUCK & EQUIPMENT SERVICES SA
17, rue des Martyrs
L-7375 LORENTZWEILER
+352 33 34 35
info@tes.lu
www.tes.lu



Guangxi LiuGong Machinery Co., Ltd.

No. 1 Liutai Road, Liuzhou, Guangxi 545007, PR China
T: +86 772 388 6124 E: overseas@liugong.com
www.liugong.com

Like and follow us:



LG-PB-835H-Stage V-24-17012022-ENG

The LiuGong series of logos herein, including but not limited to word marks, device marks, letter of alphabet marks and combination marks, as the registered trademarks of Guangxi LiuGong Group Co., Ltd. are used by Guangxi LiuGong Machinery Co., Ltd. with legal permission, and shall not be used without permission. Specifications and designs are subject to change without notice. Illustrations and pictures may include optional equipment and may not include all standard equipment. Equipment and options varies by regional availability.